

# **RIG FIELD**

Rig Field General Trading LLC



# **PRODUCT CATALOG**





RIGFIELD GENERAL TRADING LLC is a major energy industry support service provider in the region.

For over a decade, RIGFIELD GTL has been engaged in the sales and distribution of the complete range of oilfield equipment, spare parts, and accessories for oil and gas industries in Saudi Arabia, Bahrain, Qatar and UAE.

With our state of the art information platforms, inventory management and logistic support systems, RIGFIELD GTL is able to deliver prompt solutions and support to offshore sites and onshore drilling companies from our strategically placed, primary service segment in Manama.

RIGFIELD GTL is backed by a host of experienced engineers and consultants who supervise projects and offer smart solutions and recommendations as required.

Although RIGFIELD GTL is a young company, it has progressed rapidly owing to the sixty years of combined experience of its founders. The Company has associations with renowned manufacturers and major suppliers from across the globe and is unique in terms of its product range, personalized service, quality and competitiveness.

## ASSOCIATED OFFICES

### RAAS Oilfield Services & Supplies WLL

Flat No: 11 | Bldg: 5162 | Block: 606 |  
Road: 675 | Al Kharijiyah  
Kingdom of Bahrain  
T: +973-1773-0946 | F: +973-1773-0976  
sales@raasservices.com

### Ibrahim Al Shab Trading Est.

Al Salam Bldg 2, King Fahad Street  
Al Khobar 31952, Saudi Arabia  
Tel: 966 13 867 5514 / 6670  
Fax: 966 13 867 5508  
sales@alshabtrading.com  
www.alshabtrading.com

### RAK Energy Services & Supplies WLL

Flat 16, Bdg 30, Rd 790, Umm Al Dome  
Street, Muaither, Doha, State of Qatar  
Tel: 974 4427 9549  
sales@rakenergyservices.com  
www.rakenergyservices.com

in terms of its product range, personalized service, quality and competitiveness.

We have dedicated sourcing offices in UK and USA.

Our dedicated sales engineers are available 24x7 for inquiries or custom requirement analysis.

## OUR VISION

Belligerent efforts from our techno savvy team in bringing quality and unique service focusing future demands in the industry.

## OTHER SERVICES

- Sand / Garnett Blasting & Non Corrosive Coating (Dimet)
- Fabrication & Machining Jobs
- Frac tanks, Nitrogen tanks, Acid tanks, Nitrogen units, Flood lights, Generators, Fork Lifts, Cranes
- Industrial Coating and Various Linings
- Coating services
- Rental Services
- Industrial Cleaning



**DRILLING EQUIPMENT  
FLOWLINE PRODUCTS  
RELIEF VALVES**



**HAMMER UNION**

Sizes: 1" - 12"  
Max. working pressure of 15,000 PSI  
Complete traceability  
Manufactured from Forged Steel  
STM A - 105 unions > 6,000 PSI  
AISI 4130 for unions < 6,000 PSI  
Available with Charpy testing



**RING GASKETS**

ABCO provides large range ring gaskets in accordance with API-6A. We manufacture four basic types of ring gaskets; octagonal shape, oval shape, type RX and type BX. These basic shapes are used in pressures up to 10,000 psi. The dimensions are standardized and require specially grooved flanges.



**TRAVELING BLOCKS**

Sizes: 200 - 1500 tonnes  
Compact & streamlined design  
Individual sheave lubrication lines  
Designed to easily integrate with top drives  
One piece forged alloy clevis



**RELIEF VALVES**

Sizes: 2" (2,750 / 5,000 PSI) & 3" (5,000 PSI)  
Newly designed subs & seals make for longer lasting valve life for B/M2 valve  
Precision machined valves for accurate setting.  
Advanced seal offers resistance in the most abrasive drilling conditions.





**SOUTHWEST**  
OILFIELD PRODUCTS  
Quality Mud Pump Parts Since  
1947

## ABOUT SOUTHWEST

Southwest Oilfield Products is a premier oil and gas equipment manufacturer that provides our global customer base with best-in-class mud and well servicing pump solutions. We manufacture rugged and reliable equipment for your specific needs including Mud Pump Fluid Ends, Frac Pump Fluid Ends, Liners, Pistons and other consumable items.

Our Mud Pump solutions team has been an industry leader since 1947 and is renowned for providing high quality mud pump fluid ends and consumable parts such as pistons, liners, valves and seats to drilling companies across the globe. With over 65 years of manufacturing experience, our mission is to provide you with simply the best well servicing equipment and mud pump products.

Southwest Oilfield Products, Inc. is committed to delivering the highest quality products, on time, and creating positive significant impacts on our customers' projects. We strive to maintain our innovative stance in the industry while partnering with our customers to share the focus on generating solutions.



## MUD & FRACK PUMP

Suitable for a variety of fluid pumping applications, Southwest Oilfield Products pumps offer robust power and high performance in critical service applications for numerous applications. We house all spares:

1. Suction & Discharge Cover Nut
2. Valve Spring
3. Discharge Cover with Cage Connection
4. Discharge Cover Retaining Nut
5. Gauge Connection 1502 Seal
6. Inboard Power End Capscrew
7. Packing
8. Plunger
9. Plunger Stud
10. Replacement Compression Packing
11. Valve
12. Valve Seat
13. Discharge Cover
14. Fluid End Module
15. Discharge Flange Socket Head Capscrew
16. Discharge Flange D-Seal
17. Inboard Power End Capscrew
18. Discharge Flange with 2" 1502 Gauge Connection
19. Teflon B-347 Backup Ring
20. Seal Ring
21. Parker 2-347 O-Ring
22. Junk Ring
23. Valve Stop

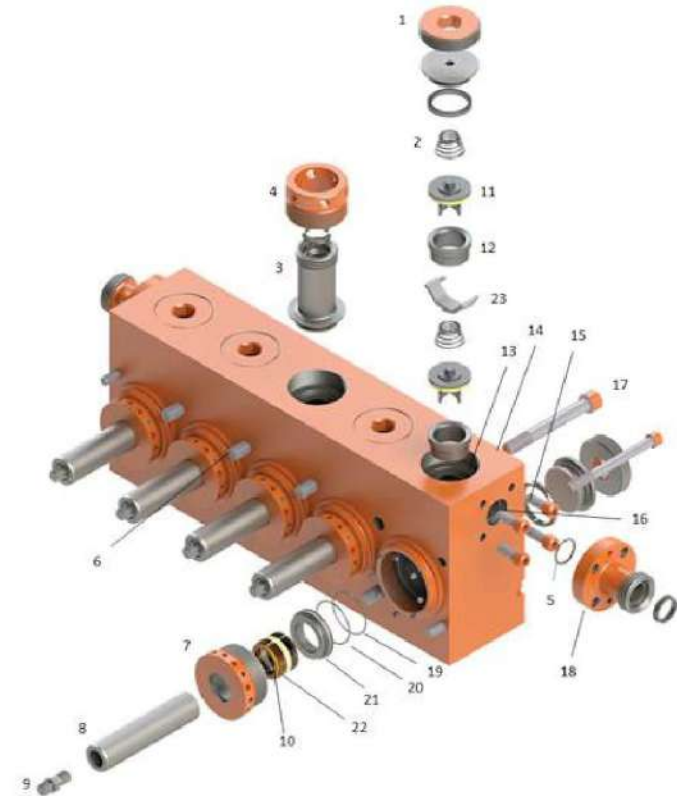



## M-PACT

The M-Pact® delivers full-coverage hand protection with a sonic welded Thermoplastic Rubber knuckle guard and dedicated finger guards that shield the top of your hand from unexpected impact and abrasion injuries. The dual-layer internal fingertip construction reinforces high wear areas of the thumb and index finger for improved abrasion resistance, while the embossed and textured fingertip pattern provides grip where you need it.



### KEY ATTRIBUTES

- Accordion knuckle guard
- Thermal Plastic Rubber (TPR) hook, loop closure, finger guards and metacarpal protection
- Armortex® fingertips
- Palm padding with high density EVA foam
- Extended Neoprene cuff
- 4mm XRD® impact pad
- TrekDry®
- Machine washable

### ORIGINAL: HMG-05-010

- 0.5mm high-dexterity palm
- Form-fitting TrekDry®
- Thermal Plastic Rubber (TPR) hook and loop closure
- Reinforcement panels in high wear areas
- Machine washable



### ORHD KNIT CR5A5

- 13-gauge knitted shell
- Thermal Plastic Rubber (TPR) knuckle, metacarpal impact protection, impact resistant finger guards, pinch-point fingertip protection.
- Textured nitrile coated palm & fingers
- 3mm internal palm padding
- Extended cuff w/ TPR hook and loop closure
- Machine washable.



### ORIGINAL: MG-05

- Form-fitting TrekDry®
- Thermal Plastic Rubber (TPR)
- Industrial grade hook and loop
- DuraHide™ leather
- Double-stitched index finger
- Seamless synthetic leather palm
- Machine washable.



### KNIT NITRILE

- 13-gauge seamless liner
- Extended Cuffs
- MicroFinish® nitrile coating
- Machine washable.



### THERMAL KNIT

- Heavyweight knit shell
- Extended cuff
- MicroFinish® palm coating
- Machine washable.





## RIGGER GRIP CUT 5

The Rigger Grip Cut 5 is built on our original Rigger glove chassis with the same exclusive Duraclad® Rope Channel Reinforcement. We added our exclusive CT5™ material for CE level 5 cut resistance covering the entire palm. It has our patented Diamondclad® outer palm for ultimate grip on wet, oily surfaces on the rig or in the field



### KEY ATTRIBUTES

- Exclusive CT5™ Cut Resistant material CE EN388 Level 5, ANSI/ISEA Level 4
- DURACLAD® Rope Channel Reinforcement
- METACARPAL Protection
- KNUCKLE Protection
- Patented DIAMONDCLAD® Silicone fused Palm Patent D568003
- KONG® Patent Pending Finger Protection



### ORIGINAL

- METACARPAL Protection
- KNUCKLE Protection
- Exclusive Palm Material
- KONG® Patent Pending Finger Protection



### SLIP AND OIL RESISTANT

- HPT - Hybrid Polymer Technology
- Exclusive Palm Material
- METACARPAL Protection
- KNUCKLE Protection
- KONG® Patent Pending Finger Protection



### RIGGER

- DURACLAD® Rope Channel Reinforcement
- METACARPAL Protection
- KNUCKLE Protection
- KONG® Patent Pending Finger



### CUT 5 KNIT

- Polyethylene Cut Resistant CE EN388 level 5, ANSI/ISEA Level 3
- Padded, Foamed-nitrile Palm
- Knuckle Protection
- 360° Cut Resistance



### CUT RESISTANT

- Exclusive CT5™ Cut Resistant material CE EN388 Level 5, ANSI/ISEA Level 4
- Exclusive Palm Material
- METACARPAL Protection
- KNUCKLE Protection
- KONG® Patent Pending Finger Protection



## RINGERS GLOVES

Ringers has hand safety experts and certified distributors in North America, South America, Europe, the North Sea, Russia, the Middle East, Africa, and Australasia. For 20 years, we have been a leader in innovative, quality products that have led us to be your global resource in hand safety expertise. No matter what industry you work in, we will help you find the product needed to keep your hands safe.



### KEY ATTRIBUTES

- TPR impact protection
- High visibility for increased safety
- CE rated for EN388 level 2 cut and puncture resistance
- TefLoc grip system
- Extended airprene wrist closure
- Kevlar stitched palm

### R-297 ROUGHNECK

- TPR impact protection
- High visibility
- CE rated for EN388 level 3 cut and puncture resistance
- KevLoc grip system
- Extended airprene wrist closure
- Kevlar stitched with padding on palm



### R-14 MECHANICS

- Split-fit padded palm
- Reflective markings
- Compression molded knuckle protection
- 3mm high density foam palm padding
- Hidden seam design
- Hook and loop rubber pull tab closure



### R-299 ROUGHNECK CUT5

- TPR impact protection
- High visibility colors
- CE rated for EN388 level 5 cut & level 4 puncture resistance
- KevLoc grip system on palm & fingers
- Extended airprene wrist closure
- Kevlar stitched palm



### R-136 TURBO PLUS

- Elastic band with hook and loop rubber pull tab closure
- Soft and durable premium mesh fabric
- Premium synthetic leather
- Wrap around index finger construction
- Lightweight fabric
- Reflective logo



### 665 R-HIDE IMPACT

- Advanced TPR impact protection
- High quality grain goatskin leather
- CE rated for EN388 level 5 cut resistance
- ANSI/ISEA rated for level 3 cut resistance
- Reinforced seams on the index finger and base of thumb
- Secured cuff closure with hook and loop TPR pull tab



## THE FINGERSAVER

Every day in many industries, people sustain hand and finger injuries that are preventable. Using correct safety device should be an essential part of everyday life. If you are working in areas where objects could hit you on the head, you would wear a hard hat. If your eyes are at risk from foreign objects or wind blown particles, you would wear safety glasses.

Think about your hands in the same way! Be sure to keep them safe and out of harms way, be sure to use the FingerSaver: don't take risks with your hands. Without the FingerSaver you are exposing yourself to potential hand or finger injuries. Your hands are your most important day to day tool. If you damage your hands, or particularly and more importantly, your fingers, you will be affected in everything you do. From getting dressed to washing your face; you will have a constant reminder of an injury that could have been avoided. Don't put your hands where they can be injured, stay safe. When using the FingerSaver you are able to keep your hands away from any potential danger of impact. The FingerSaver is designed to be held by you, or it can be held in position by a work colleague to further reduce the risk of injury. The FingerSaver tool allows you to mitigate any risk involved in the task at hand and it gives you the confidence to perform the work activity safely, without injury to your hands.



### COMPACT

At only 265mm long, the newest model in the range offers a fantastic solution when working in easy access environments where more control is needed.

Length: 265mm  
Weight: 164g



### STANDARD

The best seller of the 3 is the ideal purchase for keeping hands away from danger during use with items such as a flogging spanner.

Length: 375mm  
Weight: 200g



### LONG

The perfect solution for keeping hands and fingers away from potential danger zones when either working alone or most commonly with a colleague

Length: 850mm  
Weight: 650g



## SAFETYGRIP

SafetyGrip Solutions is one of the world's leading manufacturers of anti-slip safety products, we continue to provide our customers with a wide range of anti-slip solutions for all types of steps and stairwells; it has been proven time and again that once installed SafetyGrip anti-slip stair treads can greatly reduce the risks of slips, trips and falls around the workplace.

### CARGO GRIP

- Safer cargo handling
- Cargo & deck protection
- Improved asset integrity
- Dedicated landing areas
- Reduced maintenance costs



### KEY ATTRIBUTES

- Heavy duty / High traction
- Non corrosive
- Easy installation
- Fully guaranteed
- Tough & Durable

### RIG GRIP

- Heavy duty / High traction
- Impact resistant
- Flexible & durable
- Customised applications
- Easy installation





**AT 55° C, SLAM HIGH TEMP DOESN'T EVEN BREAK A SWEAT**

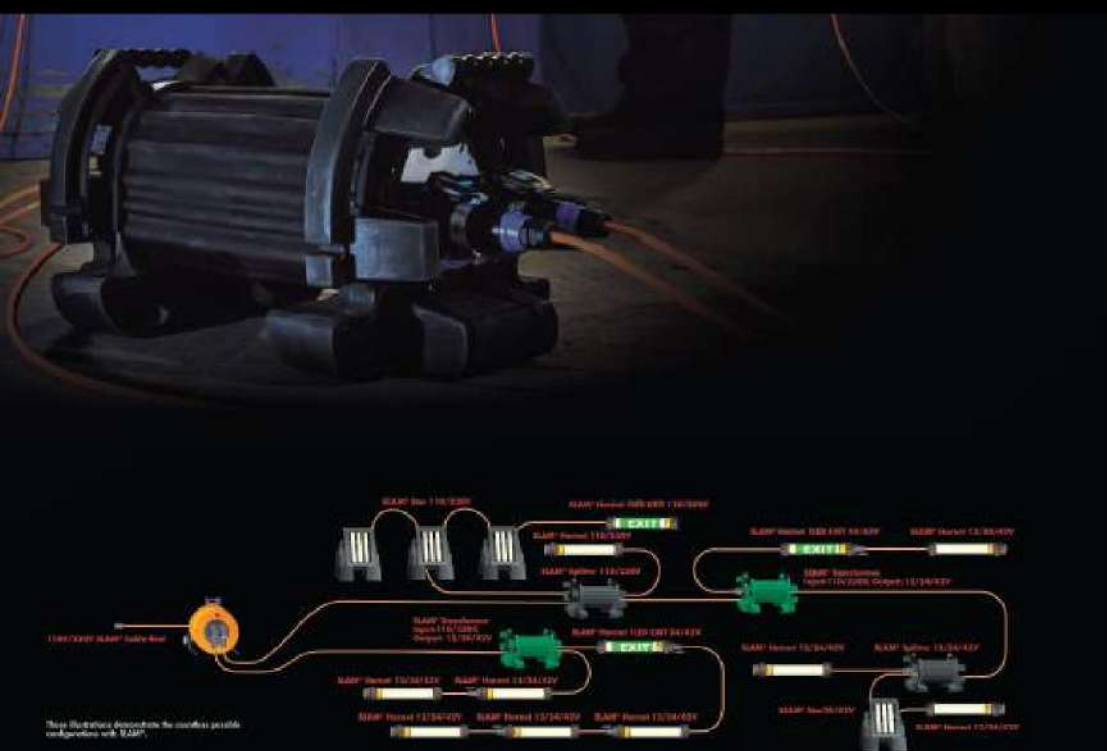

**SLAM EX-TRANSFORMERS**

Portable SLAM Ex-Transformers with full certification.



**SLAM PORTABLE EX-LIGHTS**

Portable ex-lights provide you with smooth, safe and reliable lighting. They are the ideal choice for confined spaces as they are easy to carry with. Different options are available for a variety of needs.



**SLAM CABLES AND CABLE REELS**

A comprehensive SLAM® solution is available when you need a movable electrical distribution system to ex-hazardous job sites.



**MICA INDUSTRIAL HANDLAMPS**

Rechargeable and dependable MICA® tools are suited to extreme situations. These handlamps offer safety, durability and longevity.





**MANUFACTURING QUALITY PRODUCTS SINCE 1927**



## TITAN™ CHAIN TONGS

TITAN™ CHAIN TONGS' exceptional quality ensures they will give better service in the field. The jaws are drop-forged from high-quality steel and properly hardened and tempered to stand the severe service expected of them. All sizes are equipped with heat-treated PETOL™ special chains. Replacement parts are interchangeable with other standard brands.

CATALOG	PIPE SIZE	GRIPPING WIDTH	TONG LENGTH	CHAIN TENSILE STRENGTH
C11-P	1/8" - 1-1/2"	1.75"	0"	9,400 lbs
C12-P	1/4" - 2-1/2"	2.25"	27"	13,800 lbs
C13-P	3/4" - 4"	2.63"	37"	17,600 lbs
C135-P	1" - 6"	2.88"	45"	20,100 lbs
C14-P	1-1/2" - 8"	3.06"	51"	22,000 lbs
C15-P	2" - 12"	3.25"	65"	31,000 lbs
C16-P	4" - 18"	4.63"	87"	56,000 lbs



## PETOL™ SURGRIP™ BELT TONG™

The PETOL™ BELT TONG™ strap wrench utilizes a lightweight composite strap to provide features that are truly amazing. The strap is actually stronger than chains, and you don't have to worry about rust or corrosion. The BELT TONG strap wrench is available in six sizes. The PETOL BELT TONG strap wrench is extremely easy to use.

CATALOG	O.D.™	GRIPPING WIDTH	HANDLE LENGTH	WEIGHT
SCT516	5" - 16"	9.50"	36"	280 lbs
SCT614H	6" - 14"	13.75"	33"	412 lbs
SCT1020	9-5/8" - 20"	9.50"	36"	181 lbs
SCT1020H	9-5/8" - 20"	13.75"	33"	366 lbs
SCT1838	18" - 38"	12.00"	63"	665 lbs
SCT2036	18" - 38"	12.00"	33"	295 lbs
SCT3672	36" - 72"	14.50"	33"	387 lbs



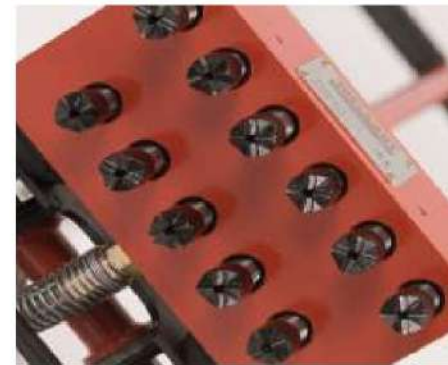

## SCALEFORCE ELEVEN PNEUMATIC DECK HAMMER (SF11)

For fast scaling of decks the walk behind SF11 is a fast, effective means of removing hard coatings and corrosion. 11 carbide tipped heads quickly fracture even the toughest materials, perfect for ongoing maintenance or preparation pre blast cleaning to speed up removal and save costs on abrasives. The floating head design allows the SF11 to easily follow deformations in the surface meaning coatings will be removed evenly and consistently.

MODEL	PART #	WEIGHT kg	HEIGHT mm	WIDTH mm	CUTTING WIDTH mm	BPM (blows per min.)	AIR CONSUM (litres/sec)	NOISE LEVEL db(A)	VIBRATION Aeq m/s <sup>2</sup>
Standard Machine w/ Dust Shroud	159.5912	38	1210	282	252	11 x 3000	33fps	113.1	5.76
Standard Machine	159.5910	36	1210	282	252	11 x 3000	33fps	113.1	5.76
Machine fitted w/ Beryllium Copper Heads	159.5930	36	1210	282	252	11 x 3000	33fps	113.1	5.76



## VIBRO-LO VL303 HEAVY DUTY PISTOL GRIP NEEDLE/CHISEL SCALER

The Trelawny VL303 heavy duty low vibration needle/chisel scaler is a Pistol Grip tool designed for the most demanding applications. It makes light work of removing heavy coatings and corrosion. Featuring Trelawny's unique Vibro Lo™ vibration reduction system the VL range offers unrivalled performance, reliability and reduction in levels of harmful vibration.

MODEL	PART #	TYPE	NEEDLE QUANTITY	WEIGHT kg	AIR INLET SIZE (BSP)	BPM (blows per min.)	AIR CONSUM (lps-cfm)	NOISE LEVEL db(A)	VIBRATION Aeq m/s <sup>2</sup>
VL223 Needle	196.2103	In-Line	19x3mm	2.35	1/4	2400	1.89 - 4	90.7	2.56
VL223 Chisel	196.2213	In-Line	-	2.95	1/4	2400	1.89 - 4	76.3	3.69
VL203 Needle	196.2003	Pistol Grip	19x3mm	2.7	1/4	2400	1.89 - 4	90.7	2.75
VL203 Chisel	196.2003	Pistol Grip	-	3.2	1/4	2400	1.89 - 4	76.3	3.33
VL303 Needle	196.3003	Pistol Grip	28x3mm	3.51	1/4	3000	2.6 - 5.5	109.5	2.3
VL303 Chisel	196.3203	Pistol Grip	-	4.25	1/4	3000	2.6 - 5.5	78.2	3.7





## GENERAL CARGO HANDLING TOOL

The unique and clever design of this tool takes into account the challenges faced by deck crew personnel and it provides a range of functions to address the associated risks. For use by deck crews to help with the positioning of various deck cargos ranging from containers, open ended half height baskets and enclosed power packs.



### KEY ATTRIBUTES

- Heavy duty aluminium staff
- Fitted with fully replaceable non-slip, low compression rubber grommets
- Tag line retrieving hook
- U & V shaped Attachments

Product Code	Hand Grip Style	Length
GCHT18001	Enclosed	1300mm
GCHT18002	Enclosed	1500mm
GCHT19002	Open	1500mm



### DRILL PIPE CASING TOOL

An extremely effective tool for promoting hands free policy in difficult operations such as casing jobs and bringing on of drill pipe.



### PRO PIPE HANDLING TOOL

A multi-functional tool, it is a vital component in the implementation of a Hands Free working environment on both the rig floor and catwalk.



### PIPE CATCHER

Ideal for the movement of drill pipe of various sizes in both vertical and horizontal positions. It is lightweight and robust.



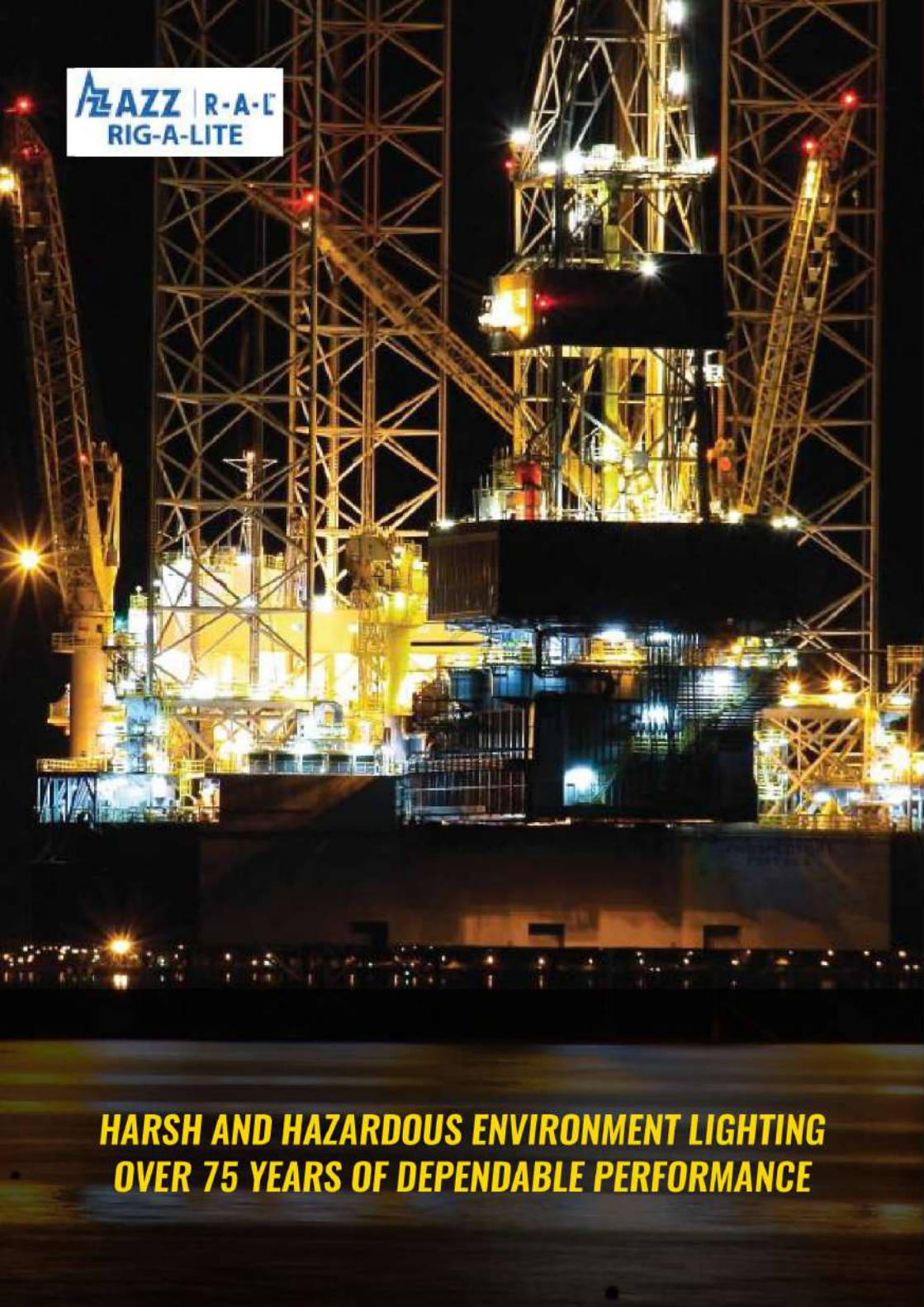

**HARSH AND HAZARDOUS ENVIRONMENT LIGHTING  
OVER 75 YEARS OF DEPENDABLE PERFORMANCE**



**AFL**

Floodlights for hazardous locations

- Precision-formed specular reflector
- Hinged copper-free, cast-aluminum lens frame
- Stainless steel slotted hex head captive screws
- Marine-grade exposed hardware
- Thermal, weather, shock, heat & impact-resistant



**CVP**

Non-metallic globe and guard lighting for hazardous and severe environments

- Non-metallic, high-impact thermoplastic housing
- Choice of glass
- Non-metallic thermoplastic protective guard
- Threads for quick and easy, trouble-free maintenance
- High-temperature silicone gasket



**EFL**

General purpose floodlight

- Precision-formed anodized aluminum segmented reflector
- Hinged copper-free, cast-aluminum lens frame
- Front opening for easy relamping and ballast access
- Marine-grade exposed hardware
- Thermal, weather, shock, heat & impact-resistant



**LFL LED**

LED flood lighting for wet and marine locations

- High-performance precision optics system
- Driver-access plate with stainless steel safety retention chain and captive hardware
- Field-replaceable LED circuit boards and drivers with quick disconnects
- Approved for high-ambient applications, up to 65°C
- Two permanent safety cable retention points





## ABOUT OFITE

Since 1982, OFI Testing Equipment (OFITE) has manufactured instruments and reagents for testing drilling fluids, completion fluids, oil-well cements, core samples, and wastewater.

All OFITE equipment is built to API specifications, where applicable. OFITE's quality system is certified to ISO 9001:2015 standards.

OFITE offers a complete line of testing equipment and replacement parts for the oilfield service and related industries. Our products are engineered to provide reliability, ease of operation, and user-friendly maintenance to keep downtime to a minimum.

As an independent manufacturer and supplier, OFITE has one priority - our customers. We prove this by offering quick response times for new orders, extensive repair services, and custom-designed equipment. With the help of our extensive worldwide distributor network, we're available to render assistance 24 hours a day 7 days a week.



### **GARRETT GAS TRAIN**

The most widely used portable instrument for the determination of soluble sulfides and carbonate concentrations in drilling fluid.



### **SAND CONTENT KIT**

This kit determines the volume percent of sand-sized particles in the drilling fluid.



### **VISCOMETER**

It is extensively used worldwide in both the field and laboratory for precisely measuring the rheological properties of drilling fluids and cement.



### **MUD BALANCE**

The 4-scale Metal Mud Balance is a modern rugged instrument that sets the industry standard for accuracy, and is easier to calibrate.



## ABOUT CEP

Since 1994, CEP has helped thousands of distributors grow their business by providing the industries most new and innovative environmental products. From serving the largest integrated national suppliers down to the local one man shops, CEP has provided environmental and safety solutions for any application. We pride ourselves in becoming the environmental solution to our customers. Many new and exciting changes have taken place at CEP. We have just finished our recapitalization of our manufacturing facility. This facility is now equipped with the newest high tech melt-blown equipment in the industry. Two new 60" biax machines with dual drum capability allow us to produce the finest sorbent materials in the marketplace. We continue to take pride in being the only sorbent manufacturer that produces under the ISO quality management system. To our customer, this guarantees the highest quality of material, on time, every time.

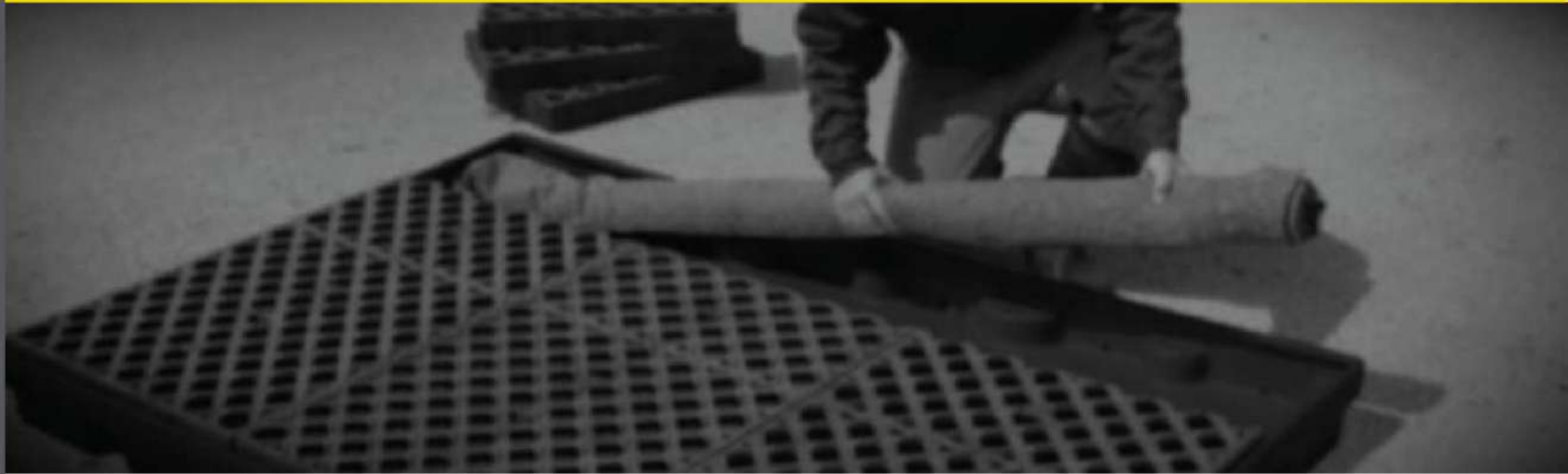

### SPILL PALLETS

CEP's secondary containment system meets the rigors of today's regulatory environment.

Part #	Hand Grip Style
5001-YE	4 Drum Poly Spill Pallet 6000
5001-YE-D	4 Drum Poly Spill Pallet 6000 w/ Drain
5253-YE	2 Drum Poly Spill Pallet 2000
5253-YE-D	2 Drum Poly Spill Pallet 2000 w/ Drain
5400-YE	4 Drum Poly Slim Line
5400-YE-D	4 Drum Poly Slim Line w/ Drain



### 64 GALLON MOBILE SPILL KIT

CEP's spill kits contain the finest quality products for oil only or universal spill control and are fully customizable!



### SORBENT PRODUCTS

CEP's supplies several kinds of sorbent products:  
 Oil Only Sorbents  
 General Purpose Sorbents  
 HazMat/Chemical Sorbents  
 Specialty Sorbents



### 95 GALLON SPILL KITS

CEP's spill kits are perfect for any and all disaster preparedness situations.

Part #	Hand Grip Style
SK95	95 Gallon Oil Only Spill Kit
GPSK95	95 Gallon General Purpose Universal Spill Kit
HAZSK95	95 Gallon Haz Mat Spill Kit





## ABOUT JOBIRD

JoBird is an internationally recognised leader in the design and manufacture of lifesaving and fire safety equipment storage.

Since its establishment in 1986, JoBird has developed its products to meet the demands of a range of industries and environments. Our Firebird GRP cabinets and Toughstore cabinets are used by clients around the world, including multinational companies such as BP, Shell, Exxon Mobil and Total.

Uniquely among UK manufacturers, we have been awarded Lloyd's Register Type Test Approval for many of our lifesaving and fire safety storage solutions. This, together with our ISO 9001 and 14001 certifications, serves as an independent endorsement of the quality of our products.



## GRP CABINETS

GRP fire extinguisher cabinets are IP56-rated and have Lloyd's Type Test Approval - making them ideal for use in demanding conditions.

The cabinets are available in a range of off-the-shelf sizes. These can store single or double 9kg and 12kg fire extinguishers, and single or double 5kg CO2 extinguishers. The Firebird range also includes a wheeled fire extinguisher cabinet with a 65kg capacity.

Code	Description
JB01	1 x 5Kg Fire Extinguisher Cabinet
JB02	2 x 12Kg Fire Extinguisher Cabinet
JB82	1 x 9-12Kg Fire Extinguisher Cabinet
JB28	1 x 5Kg CO2 Fire Extinguisher Cabinet
JB83	2 x 9-12Kg Fire Extinguisher Cabinet
JB59	2 x 5Kg CO2 Fire Extinguisher Cabinet
JB65	Wheeled Fire Extinguisher Cabinet

## ABOUT PANTHER

Panther is the pioneer in the field of safety and at the end of the nineties launched its first range of injected safety shoes, an absolute innovation in this market, it was a great success.

Today Panther is a leading manufacturer that constantly invests in sophisticated technologies and new generation materials according to the highest safety standards. Panther has both European and International certification standards: ISO 9001, CSA (Canada), ASTM (USA), BENCHMARK (Australia-New Zealand), DGUV 112-191 (for the use of orthopedic inserts in Germany).

A long established company well known for its quality and unaltered mission through decades of success, in which evolution and tradition merge into a modern design, always faithful to its DNA



STEEL MIDSOLE



ANTISTATIC FOOTWEAR



SHOCK ABSORBENT HEELS



OIL & HYDROCARBON RESISTANT



BREATHABLE UPPER



WATER REPELLANT UPPER



STEEL TOE



## RANGER 25042 OOLA

Safety Category: S3 UNI EN ISO 20345:2012

Safety boots designed for cold environments, maximum level of comfort/flexibility and lightness guaranteed.

### TECHNICAL DATA

Upper: Full grain leather water-repellent

Lining: Grain leather

Insole: Thermoformed, removable, antibacterial, absorbent FUSSTATIC

Sole: PU/Dual Density

Toe cap: Steel (200J)

Midsole: Steel

Size: 36-48

Weight (size 42): 790g



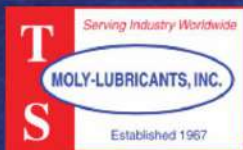

**PREMIUM GREASE**

**TS-70**

**MOLY PASTE WITH 70% MoS<sub>2</sub>  
4 LB CAN**

- Moly Paste
- 70% MoS<sub>2</sub> lubricating solids 0°F to 700°F
- Withstands corrosion and rust
- Used on subsea risers, BOP and structural bolts

**TS-264**

**SEASAFE EP GREASE  
45LB PAIL**

- SeaSafe™ EP Skid Grease
- Biodegradable and environmentally acceptable
- Used on vessel and offshore rig skids
- Superior lubrication for extreme pressure

**PREMIUM GREASE**

**TS-210**

**SEASAFE LEG DOPE AND CABLE  
LUBE 35LB PAIL**

- Environmentally safe
- Hygienically Safe
- Extreme pressure/Anti wear
- Excellent wet metal adhesion

**TS-90**

**MOLY GEAR CONCENTRATE  
5 GALLON PAIL**

- Moly Gear Concentrate Premium Additive
- Greater energy efficiency
- Reduces gear wear
- Improved gear noise levels

**PREMIUM GREASE**

**TS-66V**

**HIGH TEMPERATURE GREASE  
40LB PAIL**

- High temperature valve grease
- Resistant to the effects of H<sub>2</sub>S
- Geothermal applications

**TS-801**

**DRY FILM MOLY 12-12OZ. CANS**

- Fast evaporating
- Low coefficient of friction / good corrosion resistance
- -40°F to 600°F



**THE WORLD LEADER IN INNOVATIVE CORROSION PROTECTION SOLUTION**



### **VPCI TOTAL CORROSION CONTROL**

- Manufacturing Industry
- Packing Industry
- Concrete structures
- Metal Treatment
- High Performance Coatings
- Eco- Products
- Bio Degradable Films

### **VPCI TECHNOLOGY FOR OIL & GAS INDUSTRY**

- Upstream : Exploration & Protection
- Midstream : Transportation and Storage
- Downstream : Refining & Petrochemical

### **CORROLOGIC INNOVATIVE CORROSION INHIBITOR SYSTEMS**

- System for Above Ground Storage Tanks
- System for Insulated Pipe
- System for corrosion under Insulation
- System for Pipeline castings
- System for Fire Suppression Equipment Corrosion Inhibition
- System for Hydro testing and pigging of pipelines
- Top for the line Corrosion Protection of pipelines

### **VPCI SHRINK FILM**

- Corrosion Protection during transportation and storage
- Multi- Metal VpCI Protection VpCI – 126 Blue Milcorr shrink film

### **VPCI TECHNOLOGY FOR MARINE & SHIPBUILDING INDUSTRIES**

- Temporary protection of equipment in the construction phase of the ship and storage
- Protection of pipeline systems and tanks of the ship
- Conservation of non - operational system
- Protection of electrical circuits and control boxes

### **VPCI TECHNOLOGY FOR OFF -ROAD EQUIPMENT & MINING INDUSTRIES**

- Machinery maintenance
- Derusting products
- Cleaning Products
- Protecting/ preserving products
- Processing / Storage
- High Performance coatings for off road and mining industries



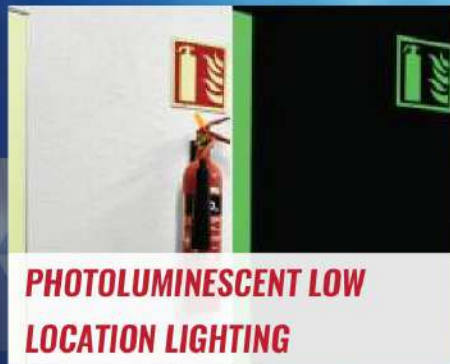

**HYDRAULIC TUBES, INSTRUMENTATION TUBES,  
COMPRESSION TUBE FITTINGS & TUBE CLAMPS**

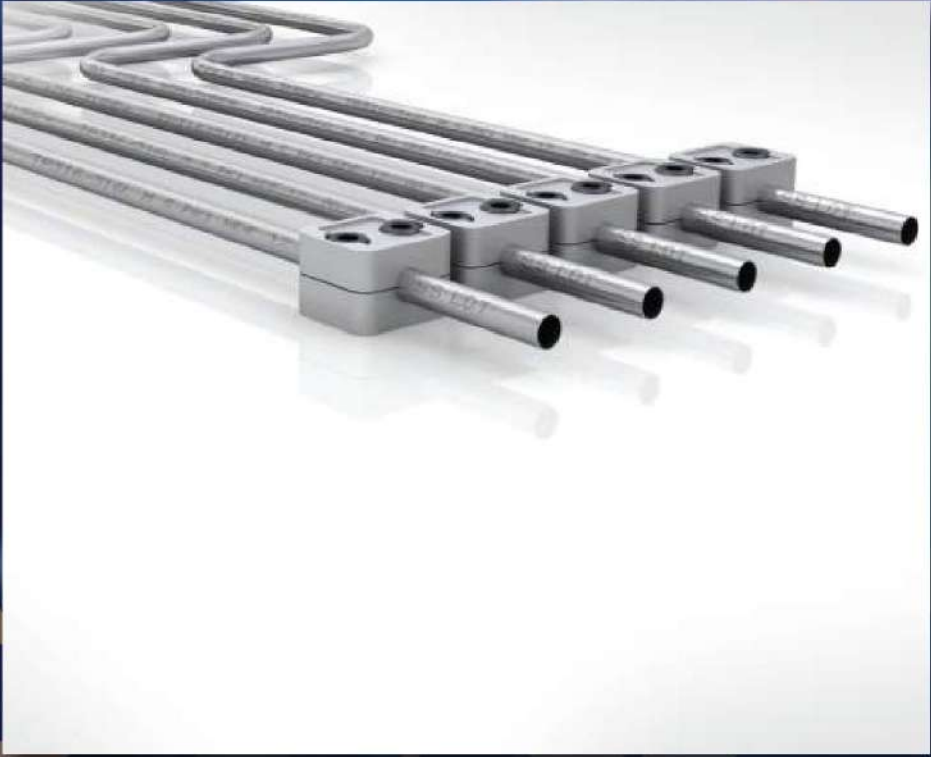



# JOINTING, FIBRE GLASS & BOILER SIGHT GLASS



**PTFE(TEFLON), NYLON & NEOPRENE BAKELITE,  
EBONITE ACRYLIC BARS**

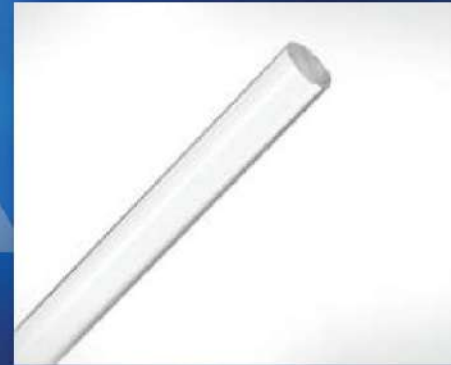





## LIFTERS



**DRUM LIFTERS**



**DRUM LIFTERS**



**BAG LIFTERS**



**BAG LIFTERS**



**PALLET LIFTERS**

## SAFETY ITEMS



**EYE WASHSTATIONS**



**SAFETY HELMETS**



**SAFETY GLASSES**



**SAFETY COVERALLS**



**SAFETY BOOTS**



**SAFETY HEARING AIDS**



**OUR STOCKING & LOGISTICS FACILITY**



**American  
Block**



**SOUTHWEST**  
OILFIELD PRODUCTS  
Quality. Reliability. Performance.

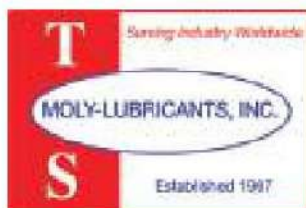

SEAWARD



*Authorized Reseller*



**GEARENCH™**





• Butterfly Valves	-	DEMCO
• Ball Valves	-	BALON / JC / JAMES BURRY
• Needle Valves	-	ANDERSON GREENWOOD / PARKER
• Float Valves	-	BAKER
• Scalars	-	TRELAWNY
• Air O Union / Tubes	-	KEMPER
• Centrifugal Pump	-	DOUBLE LIFE / MISSION MCM
• Chart Recorders / Pens	-	MD TOTCO / ITT BARTON
• Flowline / Swivel Joint Products	-	ABCO / FMC / SPM
• Drilling Lab Equipments	-	OFITE
• Diaphragm Pumps	-	WILDEN / INGERSOLLRAND
• Hammer Union	-	ABCO / KEMPER
• Hammer Seal Union	-	ABCO / KEMPER
• Ring Joint Gaskets	-	ABCO / GULF
• Safety Pins / Derrick Pins	-	USA
• Thread Protectors	-	UAE
• Thread Compounds	-	JET - JUBE / BESTOLIFE
• Tools	-	PROTO / RIDGID / GREENIE / SNAPON
• Tongs	-	GEARENCH / PARMALEE / RIDGID
• Hammer Wrenches	-	OTECO / PROTO
• Welding	-	VICTOR / MILLER / LINCOLN / TWECO
• Safety Items	-	MSA / UVEX/ JACKSON / HOWARD LEIGHT
• Protective Equipments	-	DBISALA / SPERIAN / UVEX / MSA / 3M
• Trash Compactors	-	DOLPHIN
• Shale Shaker Screens	-	DERRICK / BRANDT
• Impact Gloves	-	KONG / RINGER / MECHANIX / ERGODYNE
• Electrical / Marine Cables	-	AMERCABLE
• Explosion Proof Fittings	-	APPLETON CEAG / RIG A LITE / KILLARK
• Explosion Proof Motors	-	WEG / BALDOR / MARATHON / EMERSON
• Electrical	-	APPLETON / HUBBEL / LITHONIA
• Sirens - Manual / Electrical	-	FEDERAL ELECTRIC / NEWAGE
• Koomey Spares	-	CAD, ACCUMULATORS INC
• Engine Spares	-	DETROIT / EMD / CUMMINS / CAT
• Transmissions	-	ALLISION / CAT
• Air Compressors	-	COMPAIR / QUINCY / SULLAIR
• Hose & Fittings	-	AEROQUIP / ALFA GOMMA / PARKER / ALFAFLEX
• Pressure Gauges	-	WIKA / ASHROFT / WINTER
• Derrick Tapes	-	LUFKIN / US STEEL
• Derrick Belts / Grips	-	LEWIS
• Lifting Shackles	-	CROSBY / CM
• NDT Equipments	-	ELCOMETER / PANAMETRIES / MAGNAFLUX / CHEMTALL
• Pipe Wipers	-	OTECO
• Tong Dies	-	BJ / VARCO
• Kelly Wipers	-	BJ / VARCO
• Kelly Virator / BOP Hose	-	GOODALL / MIDWEST / COFLEXIP
• Lubricants	-	CRC / MOLYKOTE 1 / JETLUBE
• Underwater Lights	-	PELICAN
• Spill Kits	-	CEP / SPC / ENCON / 3M
• Stair Nosings	-	SAFETY GRIP
• Rig Wash	-	OMNI
• Offshore / Onshore Drilling	-	GENERAL CONSUMABLES